

Video/Audio Interfaces for TV and DVD Recorders

PAL Audio I/O Interface

BD3825FS



●Description

BD3825FS is an audio signal switch IC used for PAL DVD-Recorders. BD3825FS supports six input lines which are controlled by the I²C-BUS of video signal LSI BH7624KS2. In addition, BD3825FS has two built-in Function Switch features.

●Features

- 1) V_{cc} = ±5V (for Audio signal), +12V (for Function SW)
Audio SW (C-MOS analog switch configuration)
- 2) 3 inputs - 1output SW, (2 circuits built-in with MUTE function)
- 3) 2 inputs - 1output SW, (2 circuits built-in with MUTE function)
- 4) THD (typ.) = 0.007%
- 5) S/N (typ.) = 90dB
- 6) Crosstalk (typ.) = 90dB
- 7) ON resistance (max.) = 300Ω
- 8) 2 Function Switch outputs

●Applications

DVD-Recorder, STB, etc.

●Absolute maximum ratings (Ta=25°C)

Parameter	Symbol	Limits	Unit
Power Supply Voltage1	V ₁	±6.0	V
Power Supply Voltage2	V ₂	+13.5	V
Power Dissipation	P _d	800 *1	mW
Operating Temperature Range	Topr	-25 ~ +75	°C
Storage Temperature Range	Tstg	-55 ~ +125	°C

*1 Reduced by 9 mW/°C over 25°C.

●Operating range (Ta=25°C)

Parameter	Symbol	Limits	Unit
Supply voltage1	V _{cc1}	±4.5~±5.5	V
Supply voltage2	V _{cc2}	11.5~12.5	V

Note: This IC is not designed to be radiation-resistant.

● **Electrical characteristics** (Unless otherwise specified, Vcc1=±5.0V, Vcc2=12V, Ta=25°C)

Item	Symbol	Limit			Unit	Conditions
		MIN.	TYP.	MAX.		
< whole >						
Circuit Current 1	I _{ATYP1}	2.5	5.0	7.5	mA	Vcc1=±5V
Circuit Current 2	I _{ATYP2}	5.0	10.0	15.0	mA	Vcc2=12V
< AUX, L1_R, L OUT >						
Frequency Characteristic	F _{FC}	-1.0	0.0	1.0	dB	Vin=2Vrms, f=20Hz/100kHz R _L =47kΩ
Distortion	F _{DIS}	-	0.007	0.1	%	Vin=2.2Vrms, f=1kHz R _L =47kΩ
S/N	F _{SN}	80	90	-	dB	Vin=2Vrms, f=1kHz No Filter
ON Resistance	R _{ON}	-	200	300	Ω	Vin=0V
MUTE Attenuation	F _{MUTE}	-	-80	-75	dB	Vin=2Vrms, f=1kHz R _L =47kΩ
ASW1 SW Crosstalk	F _{SWCRS1}	-	-90	-85	dB	Vin=2Vrms, f=1kHz
ASW2 SW Crosstalk	F _{SWCRS2}	-	-90	-85	dB	Vin=2Vrms, f=1kHz
Between crosstalk channel (AUX_L ch ↔ R ch)	F _{CHCRS1}	-	-90	-85	dB	Vin=2Vrms, f=1kHz
Between crosstalk channel (L1_L ch ↔ R ch)	F _{CHCRS2}	-	-90	-85	dB	Vin=2Vrms, f=1kHz
FS_AUX, FS_L1 output voltage H	V _{FSOH}	10.0	11.0	12.0	V	R _L =10kΩ
FS_AUX, FS_L1 output voltage M	V _{FSOM}	5	5.75	6.5	V	R _L =10kΩ
FS_AUX, FS_L1 output voltage L	V _{FSOL}	0	0	1.5	V	R _L =10kΩ
ASW1,2,3,4 input voltage H	V _{ASWH}	2.0	-	+Vcc1	V	
ASW1,2,3,4 input voltage L	V _{ASWL}	0	-	1.0	V	
FS_AUX, FS_L1 input voltage H	V _{FSIH}	3.9	-	+Vcc1	V	
FS_AUX, FS_L1 input voltage M	V _{FSIM}	1.65	-	3.1	V	
FS_AUX, FS_L1 input voltage L	V _{FSIL}	0	-	0.85	V	

●Block diagram

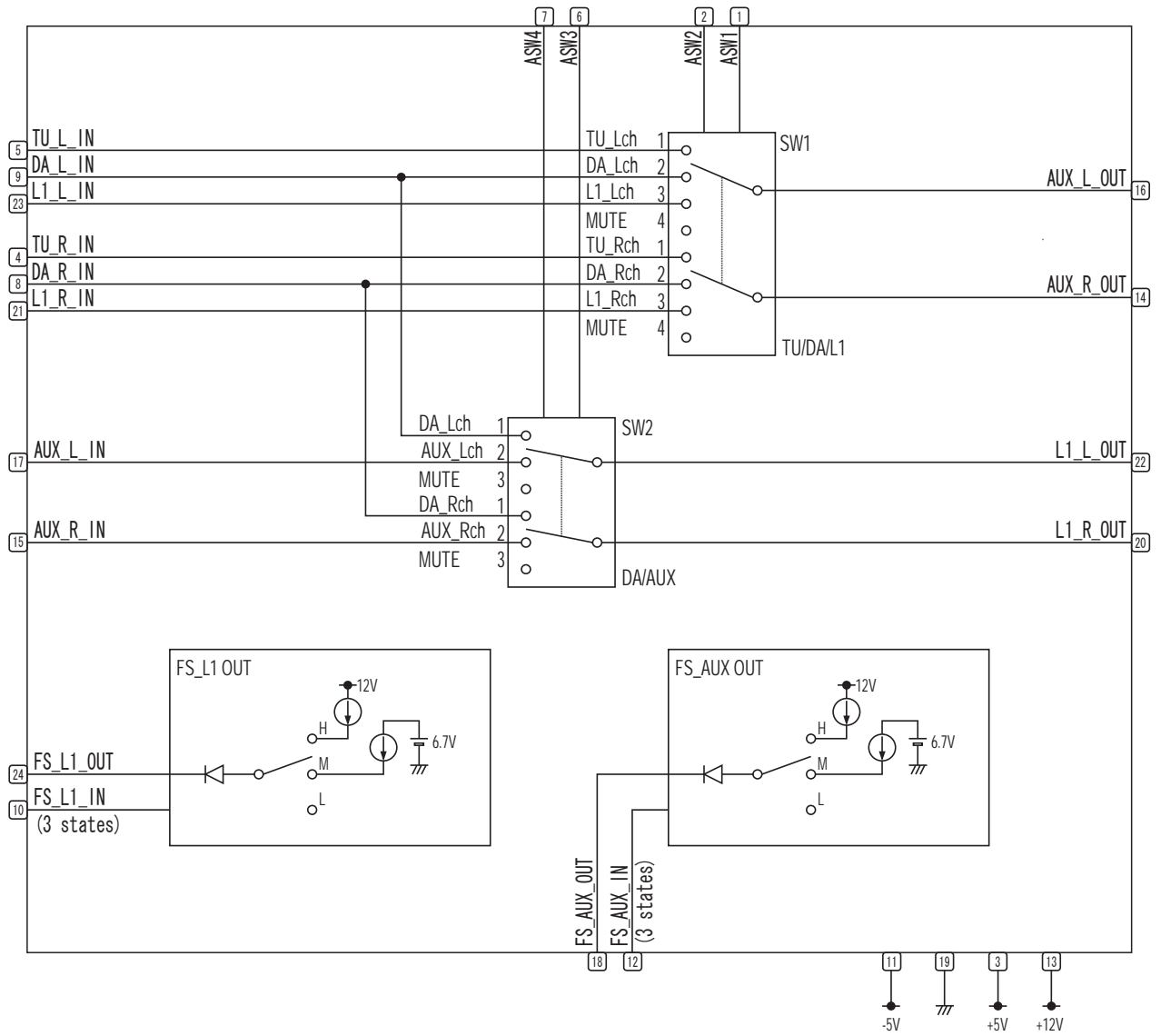
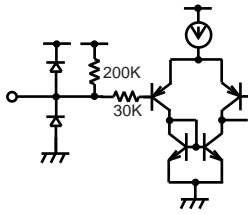
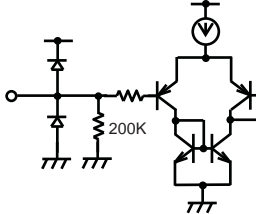
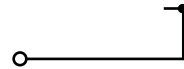
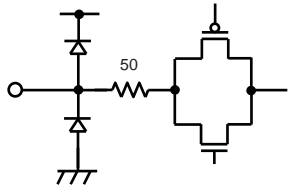
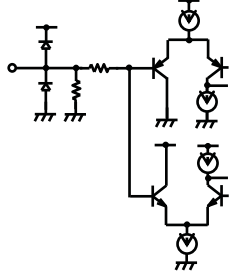
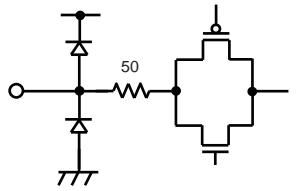
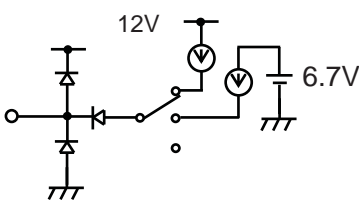
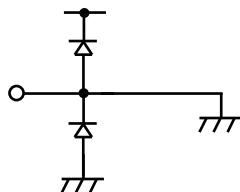

Fig.1 Block Diagram

●Equivalent circuit

PIN NO.	Pin name	IN	OUT	Reference Voltage	Equivalent Circuit	Function
1 7	ASW1 ASW4	○	—	Threshold 1.0~2.0V		SW control signal input terminal At Input open, input becomes "H" due to the pull up resistance. Input impedance is 200kΩ
2 6	ASW2 ASW3	○	—	Threshold 1.0~2.0V		SW control signal input terminal At input open, input becomes "L" due to the pull down resistance. Input Impedance is 200kΩ.
3 11 13	+5V -5V +12V	—	—	5V -5V 12V		Power supply terminal
4 5 8 9 15 17 21 23	TU_R_IN TU_L_IN DA_R_IN DA_L_IN AUX_R_IN AUX_L_IN L1_R_IN L1_L_IN	○	—	—		Audio signal input terminal The audio signal input terminal is connected to the analog switch inside.
10 12	FS_L1_IN FS_AUX_IN	○	—	Threshold 0.85~ 1.65V 3.1~ 3.9V		FS control signal input terminal It has two threshold voltages. At input open, it becomes "L" input due to the pull down resistance. Input impedance is 200kΩ
14 16 20 22	AUX_R_OUT AUX_L_OUT L1_R_OUT L1_L_OUT	—	○	—		Audio signal output terminal A chosen audio signal can be outputted using the input transfer switch.
18 24	FS_AUX_OUT FS_L1_OUT	—	○	H:11.0V M:5.75V L:0V		FS output terminal FS output circuit has 3 output states H, M & L. Load resistance above 10kΩ is used. Output becomes HiZ at "L" selection.
19	GND	—	—	0V		GND terminal

●Description of operations

① SW1, SW2

Audio input is controlled by I²C-BUS of BH7624KS2.

② FS_L1_OUT, FS_AUX_OUT

The 3 states signal (HI, MID, LOW) of the 5V standard is input into FS_L1_IN (10pin), FS_AUX_IN (12pin).

Then FS_L1_OUT (24pin), FS_AUX_OUT (18pin) output standard signal of the 12V.

This output becomes a Function Switch of the scart connector.

●SW Control truth table

SW1

ASW1	ASW2	AUX_L_OUT	AUX_R_OUT
L	L	TU_L_IN	TU_R_IN
L	H	DA_L_IN	DA_R_IN
H	L	L1_L_IN	L1_R_IN
H	H	MUTE	MUTE

SW2

ASW3	ASW4	L1_L_OUT	L1_R_OUT
L	L	DA_L_IN	DA_R_IN
L	H	AUX_L_IN	AUX_R_IN
H	L	MUTE	MUTE
H	H	MUTE	MUTE

At power Activation

ASW1 : H

ASW2 : L

ASW3 : L

ASW4 : H

● Application circuit

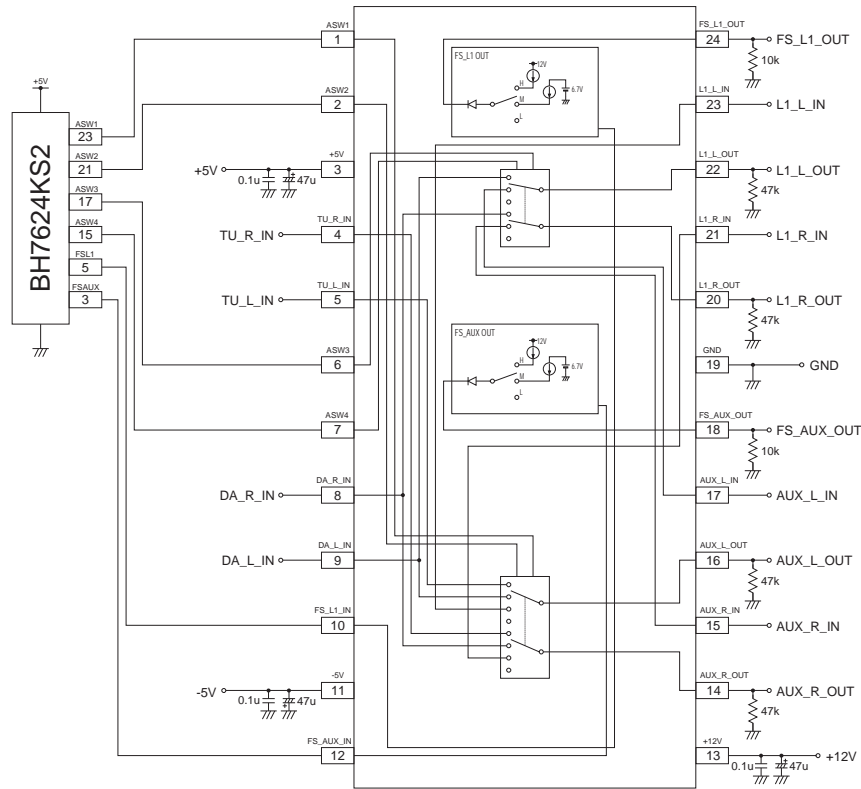

Fig.2

ASW1, 2, 3, 4, FS_L1_IN, FS_AUX_IN are controlled by I²C-BUS of BH7624KS2.

● Reference data

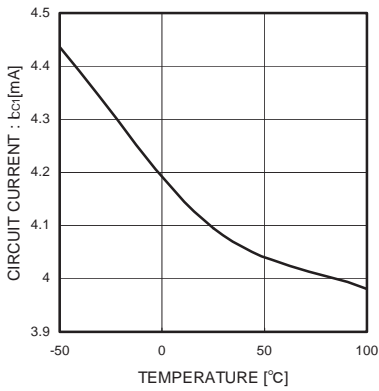

Fig3. Circuit Current1

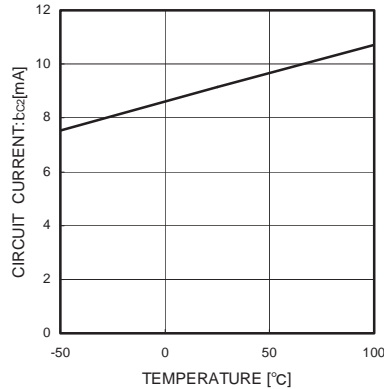

Fig4. Circuit Current2

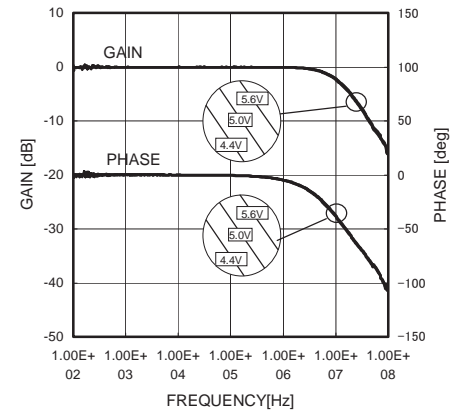

Fig5. Frequency characteristics (Supply voltage dependence)

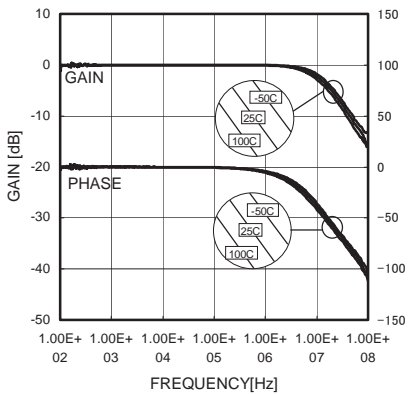

Fig6. Frequency characteristic (Temperature dependence)

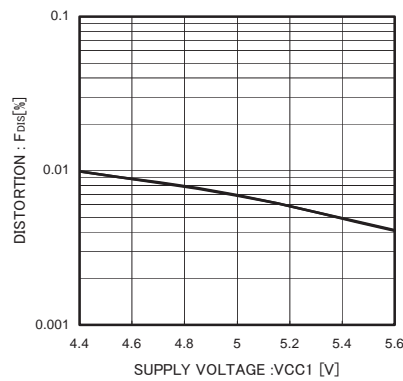

Fig7. Distortion (Supply voltage dependence)

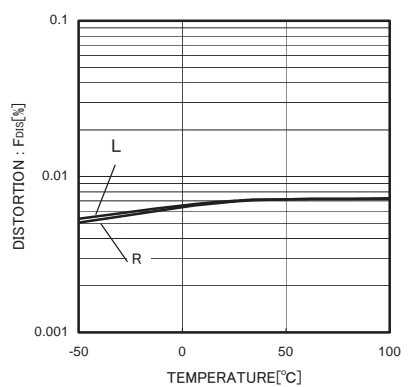

Fig8. Distortion (Temperature dependence)

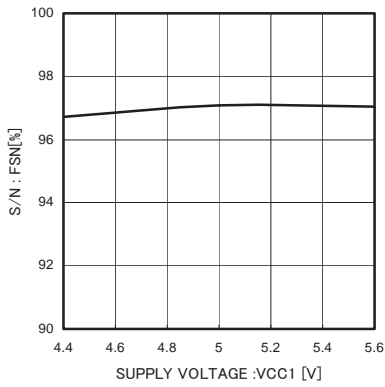

Fig9. S/N ratio
(Supply voltage Dependence)

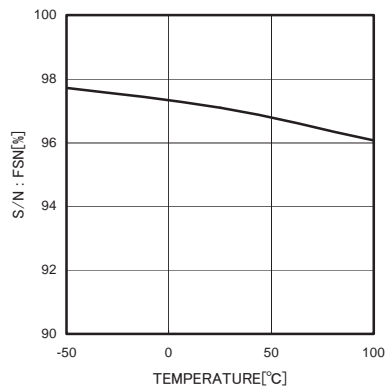

Fig10. S/N ratio
(Temperature dependence)

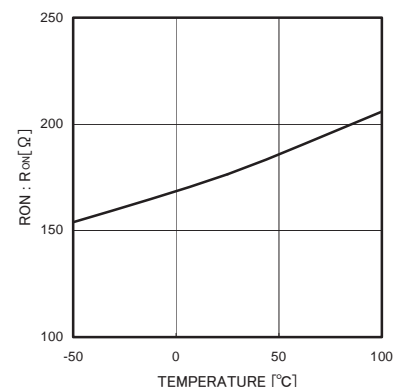

Fig11. ON Resistance

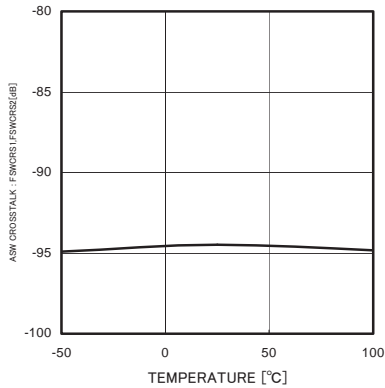

Fig12. MUTE Attenuation

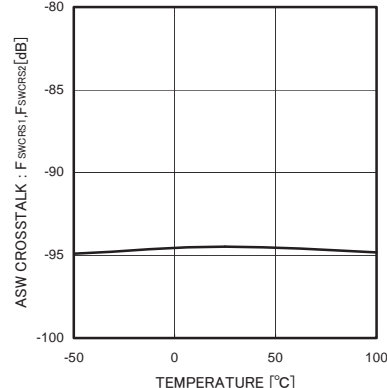

Fig13. ASW Crosstalk

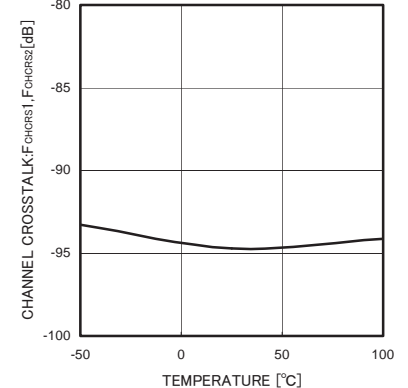

Fig14. Channel Crosstalk

●Cautions on use

- Numbers and data in entries are representative design values and are not guaranteed values of the items.
- Although ROHM is confident that the example application circuit reflects the best possible recommendations, be sure to verify circuit characteristics for your particular application. Modification of constants for other externally connected circuits may cause variations in both static and transient characteristics for external components as well as this Rohm IC. Allow for sufficient margins when determining circuit constants.
- Absolute maximum ratings

Use of the IC in excess of absolute maximum ratings, such as the applied voltage or operating temperature range (Topr), may result in IC damage. Assumptions should not be made regarding the state of the IC (short mode or open mode) when such damage is suffered. A physical safety measure, such as a fuse, should be implemented when using the IC at times where the absolute maximum ratings may be exceeded.
- 5V pin potential

Ensure a minimum -5V pin potential in all operating conditions. Make sure that no pins are at a voltage below the -5V pin at any time, regardless of whether it is a transient signal or not. <GND=0V>
- Thermal design

Perform thermal design, in which there are adequate margins, by taking into account the permissible dissipation (Pd) in actual states of use.
- Short circuit between terminals and erroneous mounting

Pay attention to the assembly direction of the ICs. Wrong mounting direction or shorts between terminals, GND, or other components on the circuits, can damage the IC.
- Operation in strong electromagnetic field

Using the ICs in a strong electromagnetic field can cause operation malfunction.
- Supply voltage

Although basic circuit function is guaranteed under normal voltage operation (5V: $\pm 4.5 \sim 5.5V$, 12V: $11.5 \sim 12.5V$), ensure each parameter complies with appropriate electrical characteristics, when using this device.
- The application circuitry example

SW and FS output are controlled by BD3825FS which in turn is controlled by BH7624KS2 and therefore, BD3825FS and BH7624KS2 should be used in conjunction. Pins 18 and 24 should be pulled down by 10kΩ resistor. Pins 1, 2, 6, 7, 10, 12 must be controlled by the microcontroller when using BD3825FS on its own.

● Selection of order type

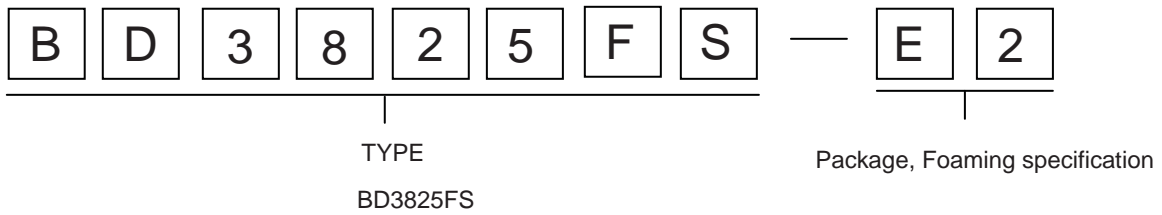

SSOP-A24

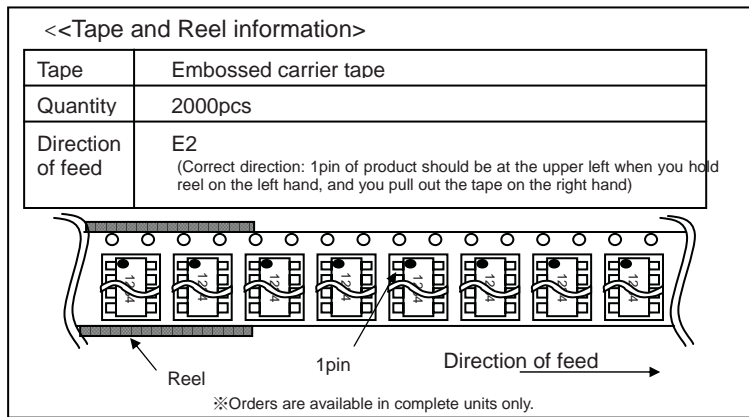
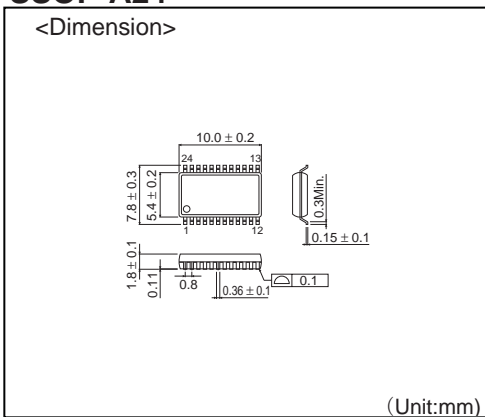

- The contents described herein are correct as of October, 2005
- The contents described herein are subject to change without notice. For updates of the latest information, please contact and confirm with ROHM CO.,LTD.
- Any part of this application note must not be duplicated or copied without our permission.
- Application circuit diagrams and circuit constants contained herein are shown as examples of standard use and operation. Please pay careful attention to the peripheral conditions when designing circuits and deciding upon circuit constants in the set.
- Any data, including, but not limited to application circuit diagrams and information, described herein are intended only as illustrations of such devices and not as the specifications for such devices. ROHM CO.,LTD. disclaims any warranty that any use of such devices shall be free from infringement of any third party's intellectual property rights or other proprietary rights, and further, assumes no liability of whatsoever nature in the event of any such infringement, or arising from or connected with or related to the use of such devices.
- Upon the sale of any such devices, other than for buyer's right to use such devices itself, resell or otherwise dispose of the same, implied right or license to practice or commercially exploit any intellectual property rights or other proprietary rights owned or controlled by ROHM CO., LTD. is granted to any such buyer.
- The products described herein utilize silicon as the main material.
- The products described herein are not designed to be X ray proof.

The products listed in this catalog are designed to be used with ordinary electronic equipment or devices (such as audio visual equipment, office-automation equipment, communications devices, electrical appliances and electronic toys). Should you intend to use these products with equipment or devices which require an extremely high level of reliability and the malfunction of which would directly endanger human life (such as medical instruments, transportation equipment, aerospace machinery, nuclear-reactor controllers, fuel controllers and other safety devices), please be sure to consult with our sales representative in advance.

Excellence in Electronics



ROHM CO., LTD.

21, Saiin Mizosaki-cho, Ukyo-ku, Kyoto
615-8585, Japan
TEL: (075)311-2121 FAX: (075)315-0172
URL <http://www.rohm.com>

Published by
Application Engineering Group

Contact us for further information about the products.

- Atlanta U.S.A. / ROHM ELECTRONICS ATLANTA SALES OFFICE
(DIVISION OF ROHM ELE.U.S.A.,LLC)
TEL: +1(770)754-6972 FAX: +1(770)754-0691
- Dallas U.S.A. / ROHM ELECTRONICS DALLAS SALES OFFICE
(DIVISION OF ROHM ELE.U.S.A.,LLC)
TEL: +1(972)312-8818 FAX: +1(972)312-0330
- San Diego U.S.A. / ROHM ELECTRONICS SAN DIEGO SALES OFFICE
(DIVISION OF ROHM ELE.U.S.A.,LLC)
TEL: +1(858)625-3630 FAX: +1(858)625-3670
- Germany / ROHM ELECTRONICS GMBH (GERMANY)
TEL: +49(2154)9210 FAX: +49(2154)921400
- United Kingdom / ROHM ELECTRONICS GMBH (UK)
TEL: +44(0)1908-306700 FAX: +44(0)1908-235788
- France / ROHM ELECTRONICS GMBH (FRANCE)
TEL: +33(0)1 56 97 30 60 FAX: +33(0)1 56 97 30 80
- Hong Kong China / ROHM ELECTRONICS (H.K.) CO., LTD.
TEL: +852(2)7406262 FAX: +852(2)375-8971
- Shanghai China / ROHM ELECTRONICS (SHANGHAI) CO., LTD.
TEL: +86(21)6279-2727 FAX: +86(21)6247-2066
- Dalian China / ROHM ELECTRONICS TRADING (DALIAN) CO., LTD.
TEL: +86(411)8230-8549 FAX: +86(411)8230-8537

- Beijing China / BEIJING REPRESENTATIVE OFFICE
TEL: +86(10)8525-2483 FAX: +86(10)8525-2489
- Taiwan / ROHM ELECTRONICS TAIWAN CO., LTD.
TEL: +886(2)2500-6956 FAX: +886(2)2503-2869
- Korea / ROHM ELECTRONICS KOREA CORPORATION
TEL: +82(2)8182-7000 FAX: +82(2)8182-715
- Singapore / ROHM ELECTRONICS ASIA PTE. LTD. (RES/REI)
TEL: +65-6332-2322 FAX: +65-6332-5662
- Malaysia / ROHM ELECTRONICS (MALAYSIA) SDN. BHD.
TEL: +60(3)7958-8365 FAX: +60(3)7958-8377
- Philippines / ROHM ELECTRONICS (PHILIPPINES) SALES CORPORATION
TEL: +63(2)807-6872 FAX: +63(2)809-1422
- Thailand / ROHM ELECTRONICS (THAILAND) CO., LTD.
TEL: +66(2)254-4890 FAX: +66(2)256-6334

Notes

- No technical content pages of this document may be reproduced in any form or transmitted by any means without prior permission of ROHM CO.,LTD.
- The contents described herein are subject to change without notice. The specifications for the product described in this document are for reference only. Upon actual use, therefore, please request that specifications to be separately delivered.
- Application circuit diagrams and circuit constants contained herein are shown as examples of standard use and operation. Please pay careful attention to the peripheral conditions when designing circuits and deciding upon circuit constants in the set.
- Any data, including, but not limited to application circuit diagrams information, described herein are intended only as illustrations of such devices and not as the specifications for such devices. ROHM CO.,LTD. disclaims any warranty that any use of such devices shall be free from infringement of any third party's intellectual property rights or other proprietary rights, and further, assumes no liability of whatsoever nature in the event of any such infringement, or arising from or connected with or related to the use of such devices.
- Upon the sale of any such devices, other than for buyer's right to use such devices itself, resell or otherwise dispose of the same, no express or implied right or license to practice or commercially exploit any intellectual property rights or other proprietary rights owned or controlled by
- ROHM CO., LTD. is granted to any such buyer.
- Products listed in this document are no antiradiation design.

The products listed in this document are designed to be used with ordinary electronic equipment or devices (such as audio visual equipment, office-automation equipment, communications devices, electrical appliances and electronic toys).

Should you intend to use these products with equipment or devices which require an extremely high level of reliability and the malfunction of which would directly endanger human life (such as medical instruments, transportation equipment, aerospace machinery, nuclear-reactor controllers, fuel controllers and other safety devices), please be sure to consult with our sales representative in advance.

It is our top priority to supply products with the utmost quality and reliability. However, there is always a chance of failure due to unexpected factors. Therefore, please take into account the derating characteristics and allow for sufficient safety features, such as extra margin, anti-flammability, and fail-safe measures when designing in order to prevent possible accidents that may result in bodily harm or fire caused by component failure. ROHM cannot be held responsible for any damages arising from the use of the products under conditions out of the range of the specifications or due to non-compliance with the NOTES specified in this catalog.

Thank you for your accessing to ROHM product informations.

More detail product informations and catalogs are available, please contact your nearest sales office.

ROHM Customer Support System

THE AMERICAS / EUROPE / ASIA / JAPAN

www.rohm.com

Contact us : webmaster@rohm.co.jp